



Mx-Series Accessories Catalogue



CONTENT

INTRODUCTION	3
STANDARD ACCESSORIES	4
ELECTRICAL ACCESSORIES.....	4
Product Detector.....	4
Beacon	5
Power Supply Cable Extension.....	6
Ethernet Cable.....	7
MECHANICAL ACCESSORIES	8
Floor Stand	8
Long Mounting Tube	9
Touchscreen Mounting Kit.....	10
Slide Bar.....	11
Beacon Mounting Plate	12
Brush On Adjustable Bracket.....	13
PREVENTIVE MAINTENANCE.....	14
Preventive Maintenance Kit.....	14
Cleaning Wipes.....	14
EXTENDED RANGE OF ACCESSORIES	16
MECHANICAL ACCESSORIES	16
Tube stands	16
Air supply	17
Air supply mounting kit	18
Air supply filter cartridge	19
Flange clamps - FKR.....	20
Base clamps.....	21
Mounting stand for scanners	22
ELECTRICAL ACCESSORIES.....	23
Scanner- Datalogic	23
Connection kit for Datalogic Scanners.....	24

INTRODUCTION

This document provides useful information about the Mx-Series accessories including photography, part numbers, descriptions, technical data, and fitting.



Note: This is a working document and will be continuously updated. The newest version of this document will always be available on MyDomino.

STANDARD ACCESSORIES

ELECTRICAL ACCESSORIES

Product Detector

This product detector is fitted on the production line and set up so that a light beam from the detector is reflected by the product itself. The reflection may be from the body of the product or from the light coloured marking on a darker background on the product. The aluminum clamp enables mounting on vertical or horizontal surfaces.

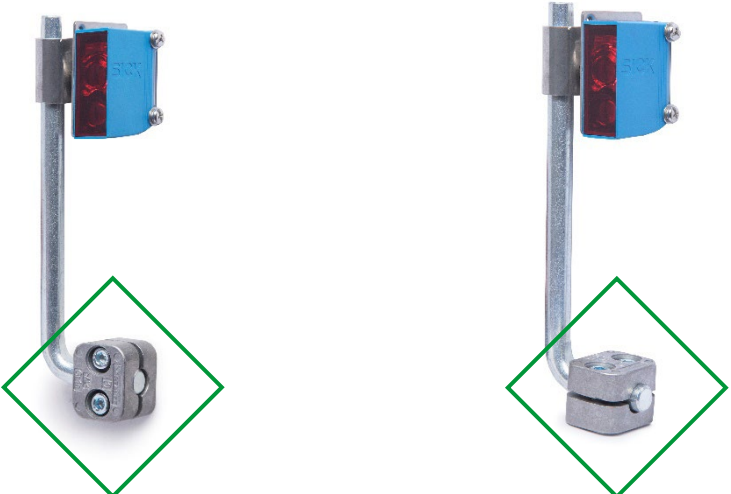
Product / Part number	Technical Data
Product detector kit EPT066140SP	<ul style="list-style-type: none"> ◆ SICK GTB10 ◆ 5 m cable ◆ Mounting details ◆ Instructions
	
	
Related accessories	
EPT066141SP	Slide bar for Product detector kit

Beacon

The beacon displays the status of the printer using a 4 colour LED system.

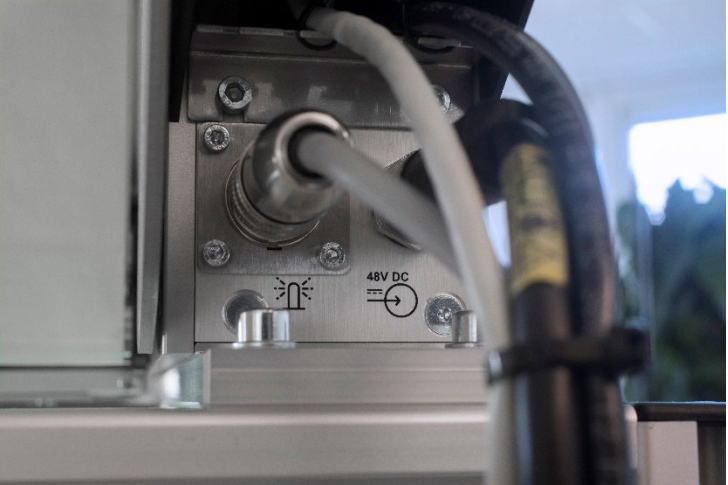
Product / Part number	Technical Data
Beacon assembly type 2 L014934	<ul style="list-style-type: none"> ◆ 24V Power supply ◆ 4 Colour LED system ◆ 3 m cable
<div style="display: flex; justify-content: space-around;">   </div>	
Related accessories	
EPT078832	Beacon mounting plate (automatically added in the configurator)

Power Supply Cable Extension

Extension cable to be used between the printer and the power supply; in addition to the 0,9 m power supply cable (M12 L-coded) fitted as default. It is recommended to use only 1 extension cable per machine, but combinations are ok given that total length is maximum 10 metres.

Product / Part number	Technical Data
Power supply cable extension 2 m – EPT077801 5 m – EPT077802 10 m – EPT077803	◆ M12 L-coded

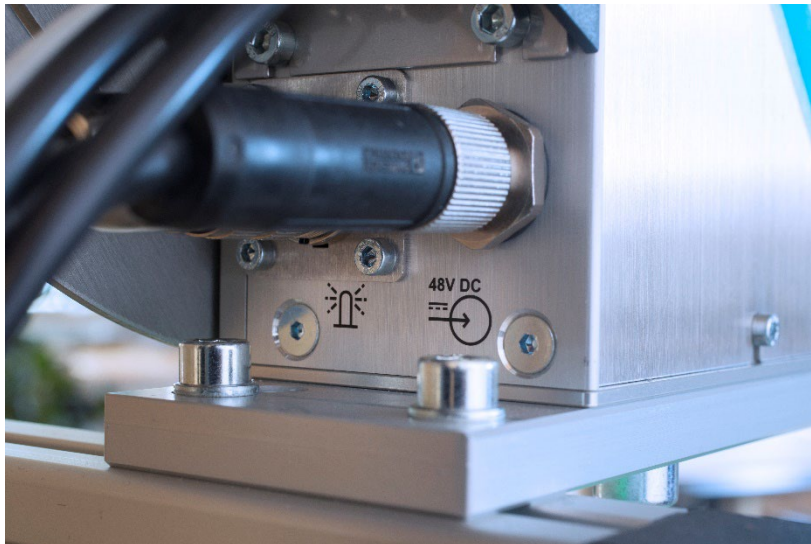

Ethernet Cable

Cable used for connecting a touchscreen to the printer.

Product / Part number	Technical Data
Ethernet cable 3m ETP078847	<ul style="list-style-type: none">◆ 3m Ethernet cable◆ Unshielded◆ Cat 5e◆ Halogen-free
	

MECHANICAL ACCESSORIES

Floor Stand

A versatile stand with unmatched flexibility, designed to be easy to use and built for tough environments. For complete technical specification, please read Stand Guide, Product brochure or Product manual, all found on MyDomino.

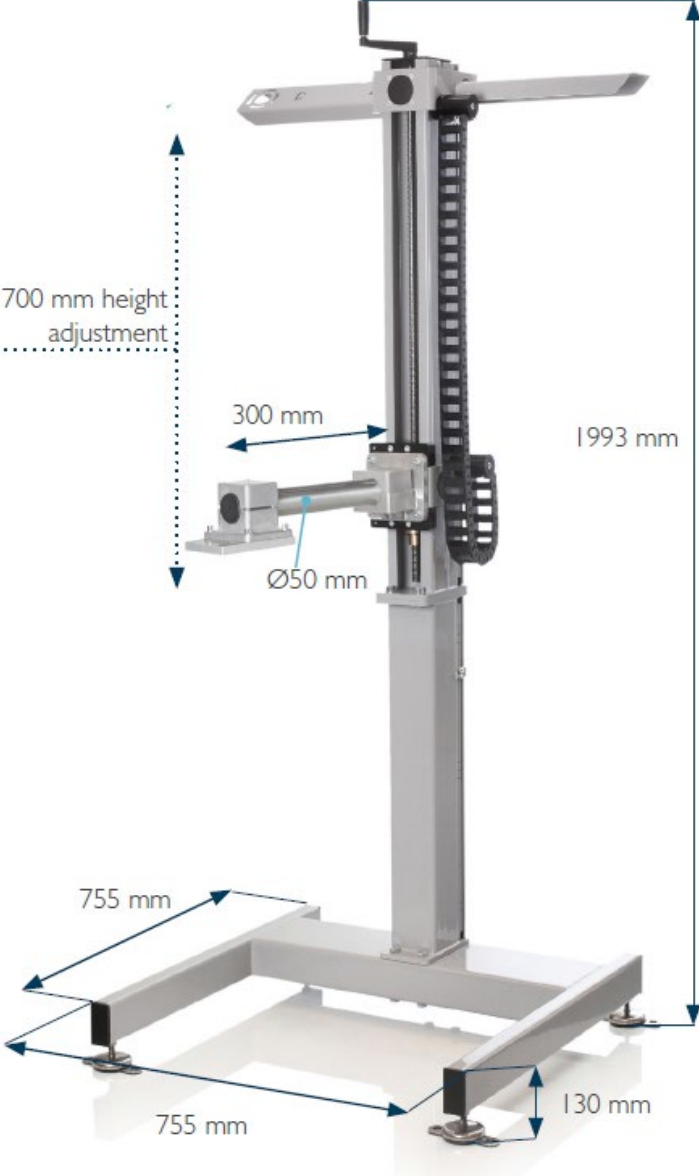
Product / Part number	Technical Data
Floor Stand MT41249	Please see Stand guide, Product brochure or Product manual.
 <p>700 mm height adjustment</p> <p>300 mm</p> <p>Ø50 mm</p> <p>1993 mm</p> <p>755 mm</p> <p>755 mm</p> <p>130 mm</p>	
Related accessories	
MT41339	Long mounting tube



Long Mounting Tube

500 mm long mounting tube which can replace the default 300 mm long mounting tube on the Floor Stand (MT41249) to give 200 mm extra horizontal reach.

Product / Part number	Technical Data
Long mounting tube MT41339	<ul style="list-style-type: none"> ◆ Ø 50 mm stainless steel ◆ 1 black end cap ◆ Length: 500 mm
	
	
Related accessories	
MT41249	Floor stand



Touchscreen Mounting Kit

Flexible mounting kit to mount a touchscreen in the most user-friendly position. Items included for mounting on the Floor Stand.

Product / Part number	Technical Data
Long arm kit - Floor stand EPT017640	<ul style="list-style-type: none"> ◆ VESA 75 screen mount ◆ Supplied as a kit, mounted on site.
	
	
Related accessories	
MT41249	Floor Stand



Slide Bar

Mounted to the conveyor with 2 included screws and with the Product detector kit attached, it offers a 400mm range of stepless adjustment along the conveyor to easily find the perfect detection position and/or allow multiple detection positions to cater for variations in the application.

Product / Part number	Technical Data
Slide bar for Product detector kit EPT066141SP	<ul style="list-style-type: none"> ◆ 500mm aluminium profile ◆ 2 screws for mounting
	
	
Related accessories	
EPT066140SP	Product detector kit

Beacon Mounting Plate

The mounting plate enables flexible mounting of your Beacon on the Floor stand. Included with the beacon when ordering complete units from configurator.

Product / Part number	Technical Data
Mounting plate EPT078832	◆ Mounting plate
	
	
Related accessories	
MT41249	Floor Stand
L014934	Beacon assembly type 2

Brush On Adjustable Bracket

A stand-alone 110 mm or 170 mm brush that can be mounted on, or beside the conveyor to brush on a label around the front corner of a product or package.

Product / Part number	Technical Data
Brush on adjustable bracket 110 mm - MT24908 170 mm - MT24909	<ul style="list-style-type: none">◆ Two adjustable aluminum profiles◆ 110 mm / 170 mm brush
	

PREVENTIVE MAINTENANCE

To ensure that the Print & Apply equipment will work optimally for many years to come, you need to regularly maintain the machine.

Preventive Maintenance Kit

The Preventative Maintenance Kit contains printer components which should be replaced proactively.

Product / Part number	Technical Data
Preventive Maintenance kit T50i & T60i EPT083222	-
 NO IMAGE AVAILABLE	

Cleaning Wipes

Product / Part number	Technical Data
Thermal printhead cleaning wipes EPT039697	<ul style="list-style-type: none"> ◆ Box of 50 sachets ◆ Read more in the SDS (Safety Data Sheet): https://ulmysds.com/customers/domino.aspx
	

In addition to the well-defined standard accessories, we offer an extended range of accessories for the Mx-Series.

EXTENDED RANGE OF ACCESSORIES

MECHANICAL ACCESSORIES

Tube stands

A robust and flexible Tube stand in stainless steel for mounting a Print & Apply unit at a fixed height. For more information, please read the Stand Guide, found on MyDomino.

Product / Part number	Technical Data
S1000TF-170 (Angle 0°, 90°, 180°, 270°) MT27002	◆ 170 cm Tube stand
S1000TF-170 (Angle 90°, 270°, horizontal) MT27003	



Air supply

Makes it possible to control and monitor the compressed air supplied to the Print & Apply unit. Thanks to a filter system it also makes sure that the air does not contain particles, water or oil. Not required for units supplied with Machine Stop Kit as it is included as a part of the kit.

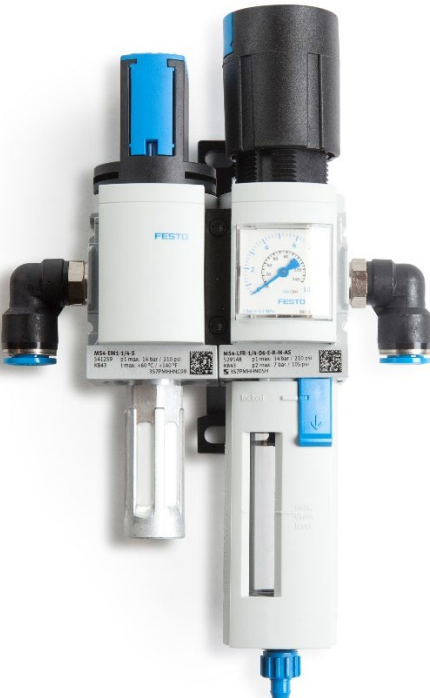
Product / Part number	Technical Data
Air kit complete MS4 left EPT023137	◆ Ø 10mm tube connection
	
Related accessories	
EPT023714	Air supply mounting kit (for Tube stands – not required for Floor stand)
EPT051826SP	Air supply filter cartridge

Air supply mounting kit

A mounting kit for Air supply, making it easy to mount it on a Tube stand or on aluminum profiles. Assembled on site.

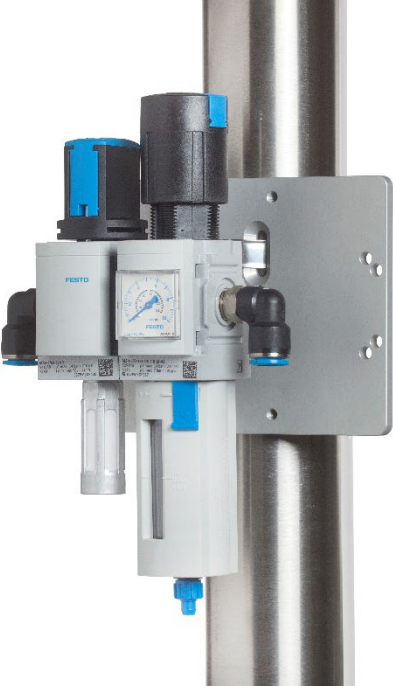
Product / Part number	Technical Data
Air supply mounting kit MS4 EPT023714	<ul style="list-style-type: none"> ◆ Mounting plate ◆ Mounting details
	
	
Related accessories	
EPT023137	Air kit

Air supply filter cartridge

Replacement filter cartridge to the Air supply kit. Makes sure that the air does not contain particles, water or oil.

Product / Part number	Technical Data
Filter cartridge EPT051826SP	◆ 2 pcs
	
Related accessories	
EPT023137	Air kit

Flange clamps - FKR

Clamps for mounting your Print & Apply unit in various angles.

Product / Part number	Technical Data
Flange clamp MT11205 – FKR 50	◆ Clamp for Ø 50 mm tube



Base clamps

Clamps for mounting your Print & Apply modules in various angles.

Product / Part number	Technical Data
Base clamp MT11220SP – FKR 50	◆ Clamp for Ø 50 mm tube

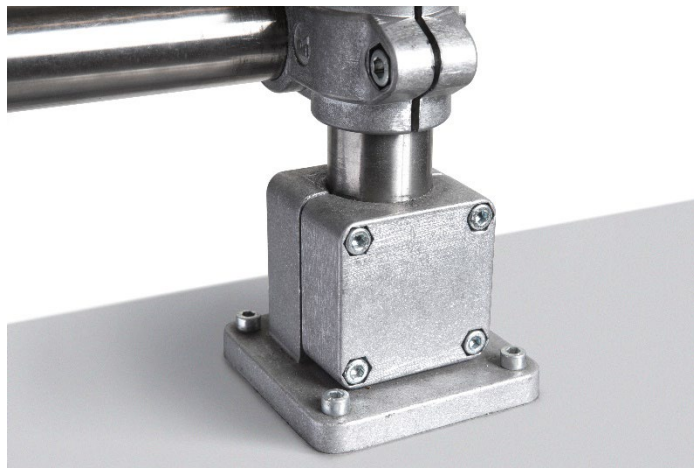
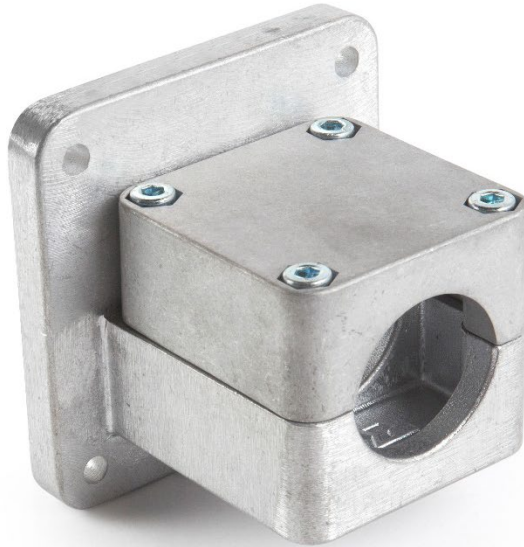

Mounting stand for scanners

A flexible stand for fixation of scanner along the conveyor.

Product / Part number	Technical Data
Stand to stationary scanner MT20229	<ul style="list-style-type: none">◆ 30 mm aluminium profiles◆ Can be bolted to floor (height 1m)
	

ELECTRICAL ACCESSORIES

Scanner- Datalogic

A linear scanner with 40-300 mm reading distance from Datalogic, for verifying the readability of printed barcodes.

Product / Part number	Technical Data
Datalogic DS2100N-1200 MT21970	◆ Datalogic product information
	
Related accessories	
MT20229	Stand to stationary scanner
EPT049357	Connection kit

Connection kit for Datalogic Scanners

A connection kit to connect an external Datalogic scanner.

Product / Part number	Technical Data
Connection kit, External scanner for Mx EPT049357	<ul style="list-style-type: none">◆ Cable, 3m◆ Screws and nuts
 NO IMAGE AVAILABLE	



Domino Mx-Series Accessories Catalogue

Domino Printing Sciences plc has a policy of continuous product improvement, the Company therefore reserves the right to modify the specification contained within this document without notice.

© Domino Printing Sciences plc 2022. All rights reserved.



For additional documentation, including other available languages, either scan the QR code, or go to <https://mydomino.domino-printing.com>

Domino UK Limited

Trafalgar Way
Bar Hill
Cambridge CB23 8TU
United Kingdom

Tel: +44 (0)1954 782551
Fax: +44 (0)1954 782874
Email: enquiries@domino-uk.com

Domino Amjet Inc.

1290 Lakeside Drive
Gurnee IL.60031
U.S.A.

Tel: +1 847 244 2501
Fax: +1 847 244 1421
Email: solutions@domino-na.com